

CH340C

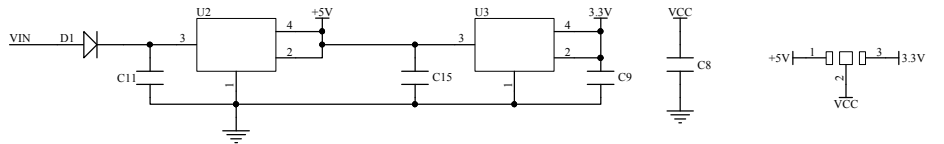

POWER

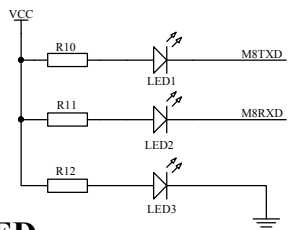

LED

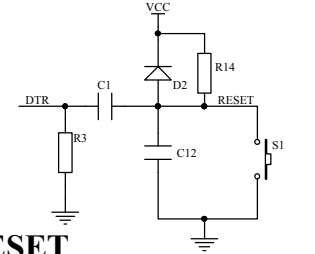

RESET

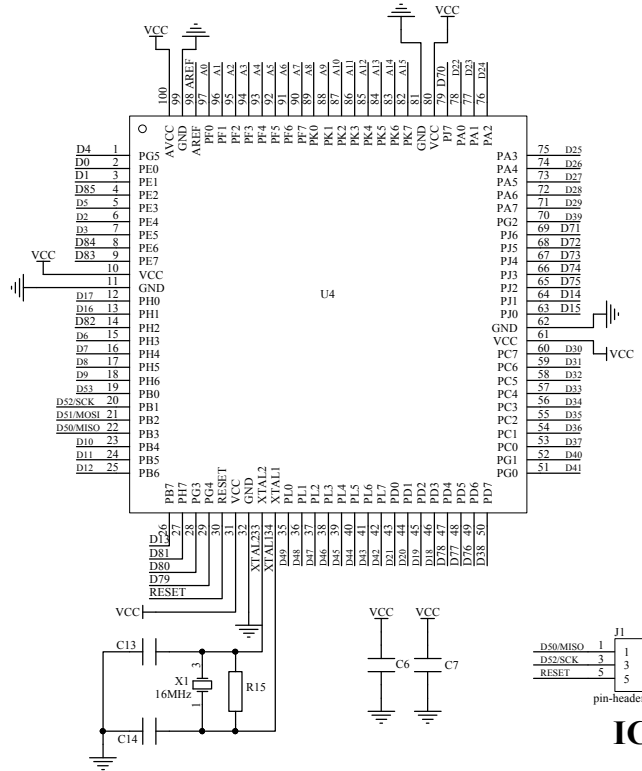

ICSP

ATmega2560-16AU

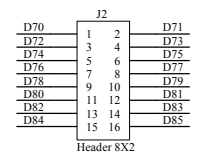
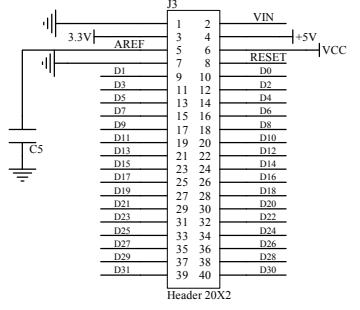
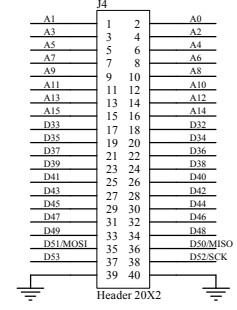
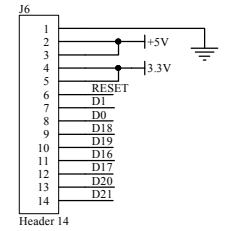
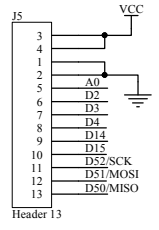

Pin-Header

RobotDyn®
www.robotdyn.com

**MCU-PRO Mega 2560 ATmega2560-16AU,
USB CH340C, 2-lines pinheaders pitch 0.1"**